



Reno A & E
4655 Aircenter Circle
Reno, NV 89502-5948 USA
Telephone: (775) 826-2020
Facsimile: (775) 826-9191
Website: www.renoae.com
E-mail: contact@renoae.com



Since 2000

MODEL 222S OPERATION MANUAL



Two-Channel DIP Switch Programmable Inductive Loop Vehicle Detector

9/25/06

This page intentionally left blank.

MODEL 222S SERIES OPERATION MANUAL

TABLE OF CONTENTS

1.0	GENERAL DESCRIPTION	5
2.0	GENERAL CHARACTERISTICS	6
2.1	Disable Channel	6
2.2	Loop Frequency	6
2.3	Fail-Safe / Fail-Secure	6
2.4	Presence / Pulse Mode	6
2.5	Sensitivity	6
2.6	Call / Test Switch.....	6
2.7	Audible Detect Signal.....	7
2.8	Test Mode	7
2.9	100 Millisecond Minimum Output	7
3.0	SPECIFICATIONS	7
3.1	Physical	7
3.2	Electrical	7
3.3	Operational	8
3.4	TABLE: Sensitivity, $-\Delta L/L$, and Response Times.....	9
3.5	TABLES: Default Settings	9
3.6	TABLES: Pin Assignments	10
4.0	USER INTERFACE.....	11
5.0	INSTALLATION AND SET-UP	12
5.1	Front Panel Programming DIP Switches	12
5.2	Front Panel Test Toggle Switches	14
5.3	Front Panel Mounted Pushbutton - Audible Detect Signal (Buzzer)	14
5.4	PC Board Mounted Programming DIP Switches	14
5.5	Loop Fail Indications	14
5.6	Resetting the Detector.....	15
6.0	BLOCK DIAGRAM	16
7.0	THEORY OF OPERATION	17
8.0	MAINTENANCE AND TROUBLESHOOTING	18
8.1	Troubleshooting Power Problems	18
8.2	Troubleshooting Loop Fail Problems	19
8.3	Troubleshooting Intermittent Loop Fail Problems.....	20
8.4	Troubleshooting Intermittent Detector Lock Ups	20
8.5	Test Mode Operation	20
8.6	Voltage and Waveform Measurements.....	25
8.7	Things To Know About Loops	26

This page intentionally left blank.

1.0 GENERAL DESCRIPTION

This Operation Manual was written for people installing, operating, and troubleshooting Reno A & E Model 222S inductive loop vehicle detectors. The Model 222S is a scanning, two channel, card rack type loop detector designed to meet or exceed the specifications for 170 and NEMA TS 1 type traffic control applications as specified in Caltrans Traffic Signal Control Equipment Specifications (TSCES) dated January 1989 (and Addendum 4 July 1991) and Caltrans Transportation Electrical Equipment Specifications (TEES) dated August 16, 2002. The Model 222S incorporates a three-position Call / Test switch for each channel that can be used to simulate a continuous or momentary CALL output.

The Model 222S uses a microcontroller to monitor and process signals from two separate loop/lead-in circuits. The operation of each channel is independently programmed with a front panel eight-position DIP switch module to provide the following selections:

- Eight Sensitivity Levels ($-\Delta L/L$ %).
- Presence or Pulse Mode.
- Fail-Safe or Fail-Secure in a loop fail condition.
- Four Frequency Selections.
- Channel Disable.

The Fail-Safe / Fail-Secure DIP switch selects the channel output state as CALL or NO CALL during a loop failure condition. The Fail-Safe selection, which is the standard for intersection control, generates a continuous CALL output state as long as a loop failure condition exists. The Fail-Secure selection generates a NO CALL output state during a loop failure condition. For traffic control applications such as incident detection, Fail-Secure operation is preferred because a constant CALL from a failed loop appears as though the traffic movement has stopped. The Fail-Secure selection also selects faster response times for very accurate speed measurement. The switch selection allows the user to set the detector operation to suit the particular application.

The Model 222S alternately excites the two loop circuits. This eliminates the possibility of adjacent loop fields coupling together (crosstalk) when the loops are connected to the same detector. Each time the loop circuit is activated, loop data is obtained and recorded. The data is compared to previous samples for both the amount and rate of change. A slow rate of change, as is the case with environmental drift, is continuously tracked. If a rapid change exceeds a threshold set by the sensitivity level, the output is activated.

Each channel has a single, dual color (green / red) Detect / Fail LED indicator. The LED provides an indication of the channel's output state and loop failure conditions. Output state conditions are indicated when the Detect / Fail LED is illuminated in a green state. Loop failure conditions are indicated when the Detect / Fail LED is illuminated in a red state.

If the total inductance of the loop input network goes out of the range specified for the detector, or rapidly changes by more than $\pm 25\%$, the channel will enter the programmed Fail-Safe or Fail-Secure mode of operation. The Detect / Fail LED will illuminate (red) to indicate that an Open Loop Failure or an inductance change condition of greater than $+25\%$ exists. The Detect / Fail LED will flash (red) at a one Hz rate to indicate a Shorted Loop Failure or an inductance change condition of greater than -25% exists. Either indication will continue as long as the loop failure exists. If the loop self-heals, the channel will resume operation in a normal manner, except the Detect / Fail LED will flash (red) at a rate of three 50 millisecond flashes per second, thus providing an alert that a loop fail condition has occurred. Any prior loop failure indication will continue until the detector is manually reset or power is removed.

The Detect / Fail LED will illuminate (green) to indicate a vehicle presence in the loop area. If a prior Loop Failure condition has occurred and detection occurs, the Detect / Fail LED will flash (red) at a rate of three 50 millisecond flashes per second followed by a single 750 millisecond flash (green). This prior Loop Failure indication will continue until the detector is manually reset or power is removed.

In addition, the Reno A&E Model 222S has a Test Mode that thoroughly tests the detector module without the need for external test equipment. The Test Mode uses the microcontroller to verify the proper operation of the entire detector's input and output circuitry including switches, LEDs and outputs. Each channel's loop oscillator circuit can also be tested to verify the correct frequency range in each of the four frequency selections.

The Model 222S Series is comprised of the following detectors:

- Model 222S-R For applications calling for a two channel, 332 (170 Controller) rack mount detector with relay outputs and an audible detect signal (buzzer) that incorporates an integral Call / Test switch.
- Model 222S-SS For applications calling for a two channel, 332 (170 Controller) rack mount detector with solid state outputs and an audible detect signal (buzzer) that incorporates an integral Call / Test switch.

2.0 GENERAL CHARACTERISTICS

2.1 Disable Channel

Each detector channel can be disabled by setting DIP switch 1 to the *ON* position. When set to the *ON* position, the channel output is continuously in the NO CALL state regardless of the presence or absence of vehicles over the loop. The loop oscillator is not activated when the channel is in the Disabled State.

NOTE: Changing the Disable Channel switch setting of an individual channel will reset that channel.

2.2 Loop Frequency

There are four (4) selectable loop frequency settings (normally in the range of 20 to 100 kilohertz) for each channel. The actual loop operating frequency is a function of the loop / lead-in network and the components of the loop oscillator circuit. Adjacent loops connected to different detectors may crosstalk and require changing of the operating frequency of one of the loop circuits. If crosstalk is a problem, select another loop frequency for stable operation. The four frequency selections are selected via DIP switches 2 and 3 on each of the two front panel mounted eight-position DIP switch modules.

NOTE: The detector channel must be reset after changing the frequency setting.

2.3 Fail-Safe / Fail-Secure

Fail-Safe or Fail-Secure mode of operation is selectable for each channel using DIP switch 4.

During a loop failure condition, the state of the channel's output can be selected as *CALL* in the Fail-Safe mode of operation or *NO CALL* in the Fail-Secure mode of operation. Fail-Safe operation during a loop failure is the standard operation for intersection control. Fail-Secure operation during a loop failure is typically used for incident detection systems for freeway management. The Fail-Secure selection also selects Fast Response for very accurate speed and occupancy measurements (See Section 3.4 for actual detection levels and response times for each sensitivity level.)

NOTE: Changing the Fail-Safe / Fail-Secure switch setting of an individual channel will reset that channel.

2.4 Presence / Pulse Mode

Two modes of operation for each channel of the detector are available. Presence or Pulse Mode is selected by setting the state of DIP switch 5 on each of the two front panel mounted eight-position DIP switch modules.

PRESENCE MODE: Provides a Call hold time of at least four minutes (regardless of vehicle size) and typically one to three hours for an automobile or truck. This is the factory default setting and the most common setting.

PULSE MODE: An output pulse of 125 ± 10 milliseconds duration is generated for each vehicle entering the loop detection zone. Each detected vehicle is instantly tuned out if it remains in the loop detection zone longer than two seconds. This enables detection of subsequent vehicles entering the loop detection zone. After each vehicle leaves the loop detection zone, the channel resumes full sensitivity within one second.

NOTE: Changing the Presence / Pulse Mode switch setting of an individual channel will reset that channel.

2.5 Sensitivity

There are eight (8) selectable sensitivity levels for each channel. The sensitivity levels are designed so that a one level increase actually doubles the sensitivity and a one level decrease halves the sensitivity. The eight sensitivity levels are selected via DIP switches 6, 7, and 8 on each of the two front panel mounted eight-position DIP switch modules. (See Section 3.4 for actual detection levels and response times for each sensitivity level.)

NOTE: Changing the Sensitivity level of an individual channel will reset that channel.

2.6 Call / Test Switch

Each detector channel can be independently set to provide a simulated CALL output. Each channel has a front panel mounted, three-position toggle switch that can be used to short the detector channel's output terminals in either a continuous (CALL) or momentary (TEST) closed state. When set to the center (NORM) position, the channel(s) operate normally. This feature is useful when troubleshooting problems related to detector outputs and / or controller inputs.

NOTE: When operating in TEST mode, the simulated CALL output is maintained as long as the toggle switch is held in the TEST position.

2.7 Audible Detect Signal

The pushbutton on the front panel labeled **BUZZER** is used to enable an Audible Detect Signal. When this feature is enabled (ON), an audible signal will be activated whenever the detection zone for the selected channel is occupied. The audible signal indicates actual occupancy of the loop detection zone. This feature allows a technician to watch the detection zone on the street and confirm correct detector operation without having to look at the detector front panel LEDs as well.

2.8 Test Mode

Test Mode uses the microcontroller to verify the proper operation of the detector's controls and indicators (switches and LEDs). Each channel's loop oscillator circuit is also tested to verify the correct frequency range in each of the four frequency selections.

2.9 100 Millisecond Minimum Output

When the detector is operating in Presence Mode, two modes of operation are available for the CALL outputs; Normal Mode or 100 Millisecond Minimum Output Mode. 100 Millisecond Minimum Output Mode can be selected via a DIP switch on the two-position DIP switch module labeled S3 located on the PC board. When this feature is **OFF**, CALL outputs will stay on only as long as the detection zone is occupied. When this feature is **ON**, every CALL output will have a minimum duration of 100 milliseconds.

3.0 SPECIFICATIONS

3.1 Physical

WEIGHT: 6.0 oz (170 gm).

SIZE: 4.50 inches (11.43 cm) high x 1.2 inches (3.05 cm) wide x 6.875 inches (17.46 cm) long including connector (not including front handle). Handle adds 1.00 inch (2.54 cm) to depth measurement.

OPERATING TEMPERATURE: -40° F to +180° F (-40° C to +82° C).

CIRCUIT BOARD: Printed circuit boards are 0.062 inch thick FR4 material with 2 oz. copper on both sides and plated through holes. Circuit board and components are conformal coated with polyurethane.

CONNECTOR: 2 x 22 contact edge card connector with 0.156 inch (0.396 cm) contact centers. Key slots located between B/2 & C/3, M/11 & N/12, and E/5 & F/6. See Section 3.6 for pin assignments.

3.2 Electrical

POWER: 10.8 to 30 VDC. 100 milliamps maximum.

LOOP INDUCTANCE RANGE: 20 to 2000 microhenries with a Q factor of 5 or greater.

LOOP INPUTS: Transformer isolated. The minimum capacitance added by the detector is 0.068 microfarad.

LIGHTNING PROTECTION: The detector can tolerate, without damage, a 10 microfarad capacitor charged to 2,000 volts being discharged directly into the loop input terminals, or a 10 microfarad capacitor charged to 2,000 volts being discharged between either loop terminal and earth ground.

RESET: Each detector channel can be manually reset by momentarily changing any switch position (except the Frequency switch). The detector can also be reset by connecting a logic ground signal to Contact C of the card edge connector or the return of power after a power loss.

RELAY RATING: The relay contacts are rated for 6 Amps maximum, 150 VDC maximum, and 180 Watts maximum switched power.

SOLID STATE OUTPUT RATING: Optically isolated. 30 VDC max. collector (drain) to emitter (source). 50 mA max. saturation current. 2 VDC max. transistor saturation voltage. The output is protected with a 33-volt Zener diode connected between the collector (drain) and emitter (source).

3.3 Operational

DETECT / FAIL INDICATORS: The detector has one super bright, high intensity, two color (green / red) light emitting diode (LED) per channel to indicate a CALL output and/or the status of any current or prior loop failure conditions. A continuous ON (green) state indicates a CALL output. A continuous ON (red) state indicates that a current open loop failure condition or an inductance change condition of greater than +25% exists. This indication also generates a CALL output if the channel is set to operate in Fail-Safe Mode. If set to operate in Fail-Secure Mode, a CALL output is not generated. A one Hz (red) flash rate indicates that a current shorted loop failure condition or an inductance change condition of greater than -25% exists. This indication also generates a CALL output if the channel is set to operate in Fail-Safe Mode. If set to operate in Fail-Secure Mode, a CALL output is not generated. A flash rate of three 50 millisecond (red) pulses indicates a prior loop failure condition. A flash rate of three 50 millisecond (red) pulses followed by a single 750 millisecond (green) pulse indicates a prior loop failure condition and a current CALL output (detect state).

If either channel has the audible detect feature activated, that channel's Detect / Fail LED will be illuminated in an orange state for any CALL output condition.

Detect / Fail LED	Meaning
OFF	No Detect / No Loop Failure Condition (No CALL Output)
Solid ON (Green)	Detect (CALL Output)
Solid ON (Orange)	Audible Detect Signal Activated Detect (CALL Output)
Solid ON (Red)	Open Loop Failure or Inductance change condition of greater than +25% exists
One Hz flash rate (Red) (50% Duty Cycle)	Shorted Loop Failure or Inductance change condition of greater than -25% exists
Three 50 ms (Red) flashes per second	Loop Failure condition occurred but no longer exists
Three 50 ms (Red) flashes per second followed by a single 750 ms (Green) flash	Loop Failure condition occurred but no longer exists and Detect (CALL Output)
Three 50 ms (Red) flashes per second followed by a single 750 ms (Orange) flash	Loop Failure condition occurred but no longer exists Audible Detect Signal Activated and Detect (CALL Output)

CALL / TEST SWITCH: Each detector channel has a front panel mounted, three-position toggle switch that can be used to short the detector channel's output terminals in either a continuous (CALL) or momentary (TEST) closed state to provide a simulated CALL output. When set to the center (NORM) position, the channel(s) operate normally.

RESPONSE TIME: Meets or exceeds NEMA TS 1-1989 and Caltrans response time specifications. Actual response times of either channel depend on the sensitivity level setting and Fail-Safe / Fail-Secure selection of that channel. When set to operate in Fail-Safe Mode, response time is 65 ms \pm 25 ms for all sensitivity levels. When set to operate in Fail-Secure Mode, Fast Response is selected. The response time varies and depends on the sensitivity level selected. See Table: *Sensitivity, - Δ L/L, and Response Times* for actual response times.

SELF-TUNING: The detector automatically tunes and is operational within two seconds after application of power or after being reset. Full sensitivity and hold time requires 30 seconds of operation.

ENVIRONMENTAL AND TRACKING: The detector is fully self-compensating for environmental changes and loop drift over the full temperature range and the entire loop inductance range.

GROUNDING LOOP OPERATION: The loop isolation transformer allows operation with poor quality loops (which may include one short to ground at a single point).

LOOP FEEDER LENGTH: Up to 5000 feet (1500m.) maximum with proper feeder cable and appropriate loops.

LOOP (FAIL) MONITOR: If the total inductance of the channel's loop input network goes out of the range specified for the detector, or rapidly changes by more than $\pm 25\%$, the channel will immediately enter the programmed Fail-Safe or Fail-secure mode of operation. The Fail-Safe mode of operation generates a continuous call during the loop failure. The Fail-Secure mode of operation does not generate a continuous call during the loop failure. The Detect / Fail LED will provide an indication to identify the type of loop failure condition that exists. A continuous ON (red) state indicates that a current open loop failure condition or an inductance change condition of greater than $+25\%$ exists. A one Hz (red) flash rate indicates that a current shorted loop failure condition or an inductance change condition of greater than -25% exists. This will continue as long as the loop fault exists. **However, if the detector is reset, or power is momentarily lost, the detector will retune if the loop inductance is within the acceptable range. If any type of loop failure occurs in one (or more) loop(s) in a group of two or more loops wired in parallel, the detector will not respond with a Fail-Safe output following any type of reset. It is essential that multiple loops wired to a common detector channel always be wired in series to ensure Fail-Safe operation under all circumstances.** If the loop self-heals, the detector will resume operation in a normal manner except that the Detect / Fail LED will begin to flash at a rate of three 50 millisecond (red) flashes per second, thus providing an alert that the detector has experienced a prior loop failure condition. During this state, the Detect / Fail LED will also illuminate for 750 milliseconds (green) for a CALL output. The Detect / Fail LED will continue this display pattern indicating the prior loop failure condition and/or detect state until the detector is manually reset or power is removed.

3.4 TABLE: Sensitivity, $-\Delta L/L$, and Response Times

Sensitivity Level	Industry Reference	DIP Switch 6	DIP Switch 7	DIP Switch 8	$-\Delta L/L$ Threshold	Response Time (Fail-Secure Mode)	Response Time (Fail-Safe Mode)
0		OFF	OFF	OFF	1.28%	3.5 \pm 2.5 ms	65 \pm 25 ms
1		ON	OFF	OFF	0.64%	3.5 \pm 2.5 ms	65 \pm 25 ms
2	Low	OFF	ON	OFF	0.32%	3.5 \pm 2.5 ms	65 \pm 25 ms
3		ON	ON	OFF	0.16%	3.5 \pm 2.5 ms	65 \pm 25 ms
4	Normal	OFF	OFF	ON	0.08%	4.5 \pm 3.5 ms	65 \pm 25 ms
5		ON	OFF	ON	0.04%	7 \pm 6 ms	65 \pm 25 ms
6	High	OFF	ON	ON	0.02%	11.5 \pm 10.5 ms	65 \pm 25 ms
7		ON	ON	ON	0.01%	21.5 \pm 20.5 ms	65 \pm 25 ms

NOTE: Entries in this table are based on the assumption that both channels are set to the same sensitivity and that the Fail-Safe / Fail-Secure settings for both channels are the same. To approximate response time for a detector with the channels set to different sensitivities and/or Fail-Safe / Fail-Secure settings, look up the response time for each channel and divide it by two, then add these times together.

3.5 TABLES: Default Settings

FRONT PANEL MOUNTED DIP SWITCHES

DIP Switch	Function	Setting	Position
1	Disable	Off	OFF
2	Frequency	0	OFF
3			OFF
4	Fail-Safe / Fail-Secure	Fail-Safe	ON
5	Presence / Pulse Mode	Presence	ON
6	Sensitivity	6	OFF
7			ON
8			ON

FRONT PANEL MOUNTED CALL / TEST SWITCHES

Function	Setting	Position
Call / Test Mode	Normal Operation	Norm

PC BOARD MOUNTED DIP SWITCHES

DIP Switch	Function	Setting	Position
1	Test Mode	Off	OFF
2	100 ms Minimum Output	Off	OFF

3.6 TABLES: Pin Assignments

SOLID STATE OUTPUTS

Pin	Function
A	DC Common
B	DC +
C	Reset Input
D	Channel 1 Loop Input
E	Channel 1 Loop Input
F	Channel 1 Output, Collector (Drain)
H	Channel 1 Output, Emitter (Source)
J	Channel 2 Loop Input
K	Channel 2 Loop Input
L	Chassis Ground
M	No Connection
N	No Connection
P	No Connection
R	No Connection
S	No Connection
T	No Connection
U	No Connection
V	No Connection
W	Channel 2 Output, Collector (Drain)
X	Channel 2 Output, Emitter (Source)
Y	No Connection
Z	No Connection

Pin	Function
1	No Connection
2	No Connection
3	No Connection
4	Channel 1 Loop Input
5	Channel 1 Loop Input
6	No Connection
7	No Connection
8	Channel 2 Loop Input
9	Channel 2 Loop Input
10	No Connection
11	No Connection
12	No Connection
13	No Connection
14	No Connection
15	No Connection
16	No Connection
17	No Connection
18	No Connection
19	No Connection
20	No Connection
21	No Connection
22	No Connection

RELAY OUTPUTS

Pin	Function
A	DC Common
B	DC +
C	Reset Input
D	Channel 1 Loop Input
E	Channel 1 Loop Input
F	Channel 1 Output, Relay Normally Open
H	Channel 1 Output, Relay Common
J	Channel 2 Loop Input
K	Channel 2 Loop Input
L	Chassis Ground
M	No Connection
N	No Connection
P	No Connection
R	No Connection
S	No Connection
T	No Connection
U	No Connection
V	No Connection
W	Channel 2 Output, Relay Normally Open
X	Channel 2 Output, Relay Common
Y	No Connection
Z	No Connection

Pin	Function
1	No Connection
2	No Connection
3	No Connection
4	Channel 1 Loop Input
5	Channel 1 Loop Input
6	No Connection
7	No Connection
8	Channel 2 Loop Input
9	Channel 2 Loop Input
10	No Connection
11	No Connection
12	No Connection
13	No Connection
14	No Connection
15	No Connection
16	No Connection
17	No Connection
18	No Connection
19	No Connection
20	No Connection
21	No Connection
22	No Connection

4.0 USER INTERFACE

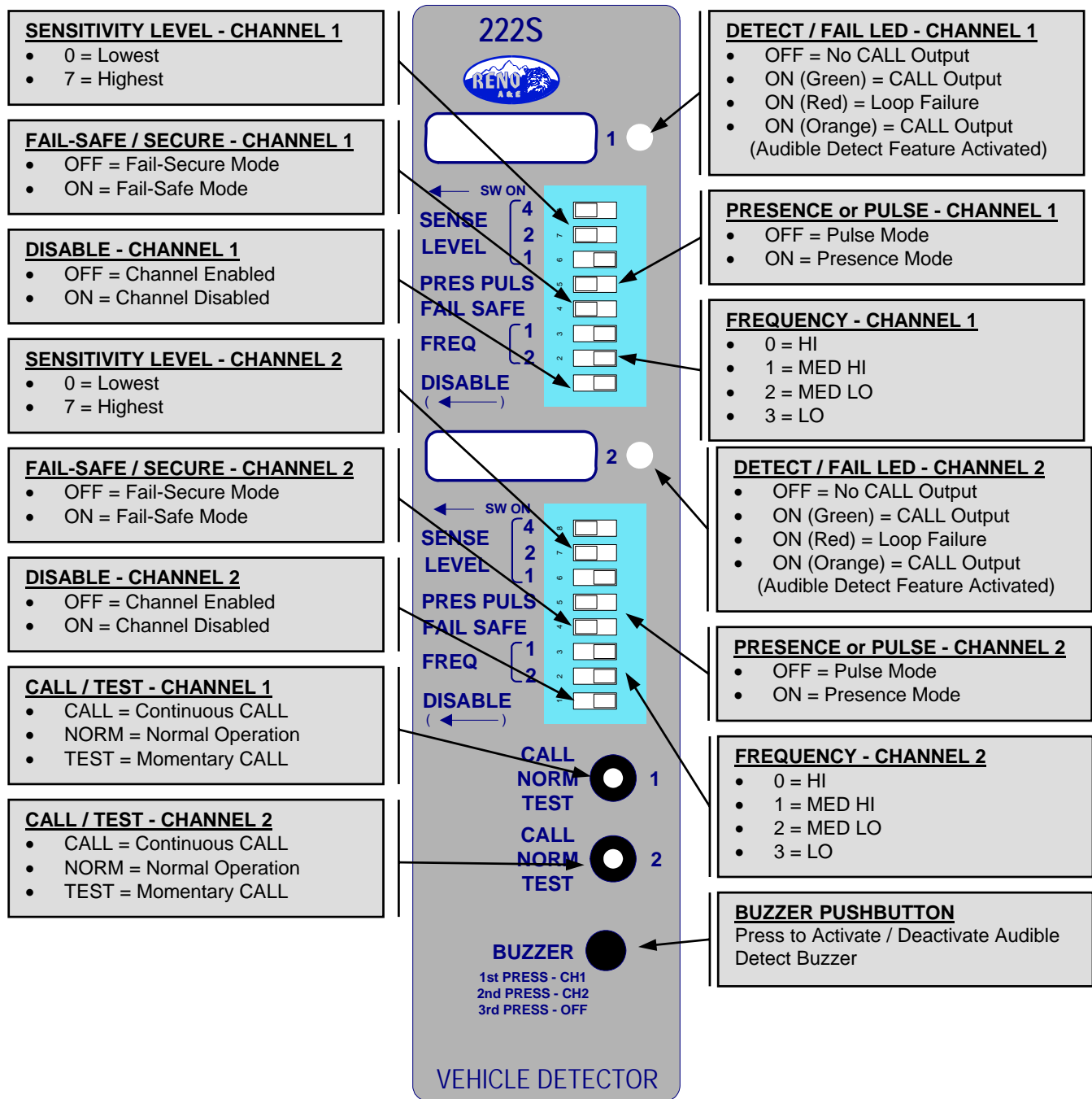

NOTE: There is a two-position DIP switch module (S3) located in the upper right quadrant of the PC board. DIP switch 1 must be in the **OFF** position for the detector to function properly.

5.0 INSTALLATION AND SET-UP

Each channel has a front panel mounted eight-position DIP switch module and a front panel mounted CALL / TEST switch that are used to control the operation of the channel. There is also a two-position DIP switch module located in the upper right quadrant of the PC board. The various switches can be set before or after the detector card is inserted into a card rack wired with appropriate contact assignments. The PRESENCE / PULSE, FAIL-SAFE, and DISABLE switches on the eight-position DIP switch modules and the 100 MILLISECOND MINIMUM OUTPUT switch on the two-position DIP switch module can be pre-selected for the desired modes operation. The SENSE LEVEL and FREQUENCY switches may require adjustment after the detector card has been inserted into the card rack. When the detector is inserted, each channel will automatically tune to the loop circuit and begin operation within two seconds.

Ensure that DIP switch 1 labeled TEST on the two-position DIP switch module located in the upper right quadrant of the PC board is set to the OFF position. This switch must be OFF for the detector to operate correctly. Set both CALL / TEST toggle switches to their NORM positions. Plug the detector into an appropriately wired card rack receptacle and apply power.

5.1 Front Panel Programming DIP Switches

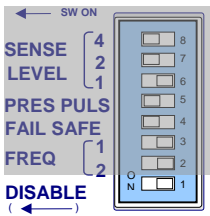

Channel Disable: When DIP switch 1 is in the *ON* position, the channel is disabled. Disabling a channel causes its output to remain in the *NO CALL* state. This switch is typically turned *ON* when a detector channel is not being used or has no loop connected to it. Disabling a channel will keep the channel's Detect / Fail LED from displaying a loop fail indication when the channel does not have a loop connected to it. When a channel is disabled, its loop oscillator is disabled as well. The factory default setting is *OFF* (Channel Disable Off).

NOTE: Changing the setting of this switch will reset the channel.

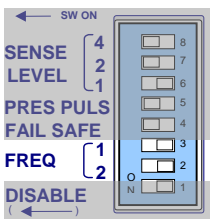

Frequency: The Model 222S detector sequentially activates each channel's loop circuit; so crosstalk between adjacent loops connected to different channels of the same detector is normally not a concern. Adjacent loops connected to different detectors may crosstalk. This may require changing the operating frequency of one of the loop circuits. If crosstalk is a problem, select another loop frequency for stable operation. Each channel of the Model 222S has four frequency selections that allow altering the resonant frequency of the loop circuit. The four frequency selections are selected with two switches marked 2 and 3 on the DIP switch module. The value (**1** or **2**) to the left of the DIP switch is assigned to the switch when the switch is *ON*. If the switch is *OFF*, the switch has a value of zero (0). By adding the switch *ON* and *OFF* values, the two switches can combine for values from 0 to 3 that indicate one of the four frequency selections. Use the following table as a reference for the selections and frequency settings. The factory default setting of these switches is switch 2 *OFF* and switch 3 *OFF* (HI).

NOTE: After changing any frequency switch setting(s), it is necessary to reset the detector channel by momentarily changing one of the other switch positions.

Frequency	DIP Switch 2	DIP Switch 3	Switch Values
HI *	OFF *	OFF *	0 + 0 = 0 *
MED HI	ON	OFF	1 + 0 = 1
MED LO	OFF	ON	0 + 2 = 2
LO	ON	ON	1 + 2 = 3

* Factory default setting.

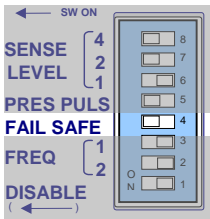

Fail-Safe / Fail-Secure: DIP switch 4 sets the default state of the channel's output when a loop failure condition exists on the loop network connected to the channel. One of two output states, shown in the table below, can be selected during a loop failure condition.

Operation	Detect / Fail LED	Output State
Fail-Safe	Solid ON (Red) or One Hz flash rate (Red)	CALL
Fail-Secure	Solid ON (Red) or One Hz flash rate (Red)	NO CALL

When the switch is in the **ON** position, the Fail-Safe mode of operation is selected. Fail-Safe operation during a loop failure is the standard mode of operation for intersection control. When the switch is in the **OFF** position, the Fail-Secure mode of operation is selected. Fail-Secure operation during a loop failure is typically used in incident detection systems for freeway management. Selecting Fail-Secure operation also selects Fast Response (see Response Time in Section 3.3). The factory default setting of this switch is **ON** (Fail-Safe Mode).

NOTE: Changing the setting of this switch will reset the channel.

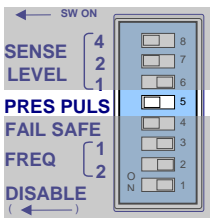

Presence / Pulse Output Mode: One of two output modes can be selected for each channel via DIP switch 5.

PRESENCE (PRES): When the switch is in the **ON** position, Presence Mode is selected. Presence Mode provides a call hold time of at least four minutes (regardless of vehicle size) and typically one to three hours for an automobile or truck. This is the factory default setting and the most common setting.

PULSE (PULS): When the switch is in the **OFF** position, Pulse Mode is selected. Pulse Mode will generate a single 125 millisecond pulse output for each vehicle entering the loop detection zone. Any vehicle remaining in the loop detection zone longer than two seconds will be tuned out providing full sensitivity for the vacant portion of the loop detection zone. Full sensitivity for the entire loop detection zone is recovered within one second following the departure of any vehicle that has occupied the loop detection zone longer than two seconds.

NOTE: Changing the setting of this switch will reset the channel.

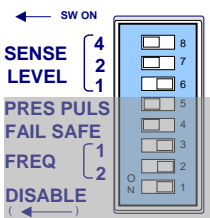

Sensitivity: Each detector channel has eight sensitivity levels that are selected with three switches marked 6, 7, and 8 on the DIP switch module. The value (**1**, **2**, or **4**) to the left of the DIP switch is assigned to the switch when the switch is **ON**. If the switch is **OFF**, the switch has a value of zero (0). By adding the switch **ON** and **OFF** values, the three switches can combine for values from 0 to 7 that indicate one of the eight sensitivity level selections. Choose the lowest sensitivity level that will consistently detect the smallest vehicle that must be detected. Do not use a sensitivity level any higher than necessary. The following table shows the actual sensitivity for each combination of switch settings. The factory default settings of these switches is switch 6 **OFF**, switch 7 **ON**, and switch 8 **ON** (Sensitivity Level 6, $-\Delta L/L = 0.02\%$).

NOTE: Changing the sensitivity setting will reset the channel.

Sensitivity Level	Industry Reference	DIP Switch 6	DIP Switch 7	DIP Switch 8	Switch Values	$-\Delta L/L$ Threshold
0		OFF	OFF	OFF	$0 + 0 + 0 = 0$	1.28%
1		ON	OFF	OFF	$1 + 0 + 0 = 1$	0.64%
2	Low	OFF	ON	OFF	$0 + 2 + 0 = 2$	0.32%
3		ON	ON	OFF	$1 + 2 + 0 = 3$	0.16%
4	Normal	OFF	OFF	ON	$0 + 0 + 4 = 4$	0.08%
5		ON	OFF	ON	$1 + 0 + 4 = 5$	0.04%
6 *	High *	OFF *	ON *	ON *	$0 + 2 + 4 = 6 *$	0.02% *
7		ON	ON	ON	$1 + 2 + 4 = 7$	0.01%

* Factory default setting.

5.2 Front Panel Test Toggle Switches

The Model 222S detector has two front panel mounted three-position toggle switches labeled 1 and 2 that can be used to simulate a CALL output. Each detector channel can be independently set to provide a simulated CALL output. When the toggle switch for a given channel is in its center (NORM) position, the detector channel operates in a normal manner. The detector channel responds to vehicle presence in the loop detection area and outputs a CALL signal whenever a vehicle is detected. The toggle switches can be used to short the detector channel's output terminals in either a continuous (CALL) or momentary (TEST) closed state, and thereby provide a simulated CALL output. This feature is useful when troubleshooting problems related to detector outputs and / or controller inputs.

NOTE: When operating in TEST mode, the simulated CALL output is maintained as long as the toggle switch is held in the TEST position.

5.3 Front Panel Mounted Pushbutton - Audible Detect Signal (Buzzer)

The pushbutton on the front panel labeled **BUZZER** is used to enable an Audible Detect Signal. When this feature is enabled (ON), an audible signal will be activated whenever the detection zone for the selected channel is occupied. The audible signal indicates actual occupancy of the loop detection zone. Only one channel can be turned on at a time. Turning this feature on for one channel automatically turns it off for the other channel. To activate this feature, press the pushbutton. The first time the pushbutton is pressed, a short (50 millisecond) audible signal confirms the activation of the feature for Channel 1. The second time the pushbutton is pressed, two short (50 ms) audible signals confirm the activation of the feature for Channel 2. To deactivate this feature, press and hold the pushbutton for one second. A long (250 millisecond) audible signal confirms the deactivation of the feature. This feature is automatically disabled 15 minutes after activation or on loss of power.

NOTE: When operating in Pulse Mode, the audible detect signal will cease once a vehicle has occupied the detection zone for more than two seconds.

5.4 PC Board Mounted Programming DIP Switches

Test: Test Mode uses the microcontroller to verify the proper operation of the detector's controls and indicators (switches and LEDs). Each channel's loop oscillator circuit is also tested to verify the correct frequency range in each of the four frequency selections. Test Mode is selected by means of DIP switch 1 on the two-position DIP switch module located in the upper right quadrant of the PC board. Refer to Section 8.5 for a complete explanation of Test Mode operation. The factory default setting of this switch is **OFF** (Test Mode Off).

100 Millisecond Minimum Output: Two modes of operation are available for the CALL outputs of the detector when operating in the Presence Mode. Normal Mode or 100 Millisecond Minimum Output Mode is selected by means of DIP switch 2 on the two-position DIP switch module located in the upper right quadrant of the PC board. When this switch is in the **OFF** position, the CALL outputs stay on only as long as the detection zone is occupied. When this switch is in the **ON** position, every CALL output will have a minimum duration of 100 milliseconds. This feature is used to ensure that CALLs output by the detector will be seen by the controller. Some controllers do not check the detector outputs often enough to catch very short detection events (<100 ms). This feature forces all detection events less than 100 milliseconds long to be 100 milliseconds long. The factory default setting of this feature is **OFF** (100 Millisecond Minimum Output Off).

5.5 Loop Fail Indications

The Detect / Fail LED for each channel indicates loop failure problems according to the following table. The Detect / Fail LED is illuminated in a red state to provide an indication of either a current or prior out of tolerance (loop failure) condition. A continuous ON (red) state indicates that a current open loop failure condition or an inductance change condition of greater than +25% exists. A one Hz (red) flash rate indicates that a current shorted loop failure condition or an inductance change condition of greater than -25% exists. If the loop self heals, the channel will resume operation in a normal manner except that the Detect / Fail LED will begin to flash at a rate of three 50 millisecond (red) flashes per second, thus providing an alert that the channel has experienced a prior loop failure condition.

Detect / Fail LED	Meaning
OFF	No Loop Failure
Solid ON (Red)	Open Loop Failure or Inductance change condition of greater than +25% exists
One Hz flash rate (Red) (50% Duty Cycle)	Shorted Loop Failure or Inductance change condition of greater than -25% exists
Three 50 ms (Red) flashes per second	Loop Failure condition occurred but no longer exists

5.6 Resetting the Detector

Changing the position of any of an individual channel's front panel mounted DIP switches (except the Frequency switch) resets the channel. When the detector is installed and operating, the most convenient method for resetting is to momentarily change the position of the PRESENCE / PULSE DIP switch and then return it to its original position. The detector can also be reset by connecting a logic ground signal to Contact C of the edge card connector or by the reapplication of power after a power loss.

6.0 BLOCK DIAGRAM

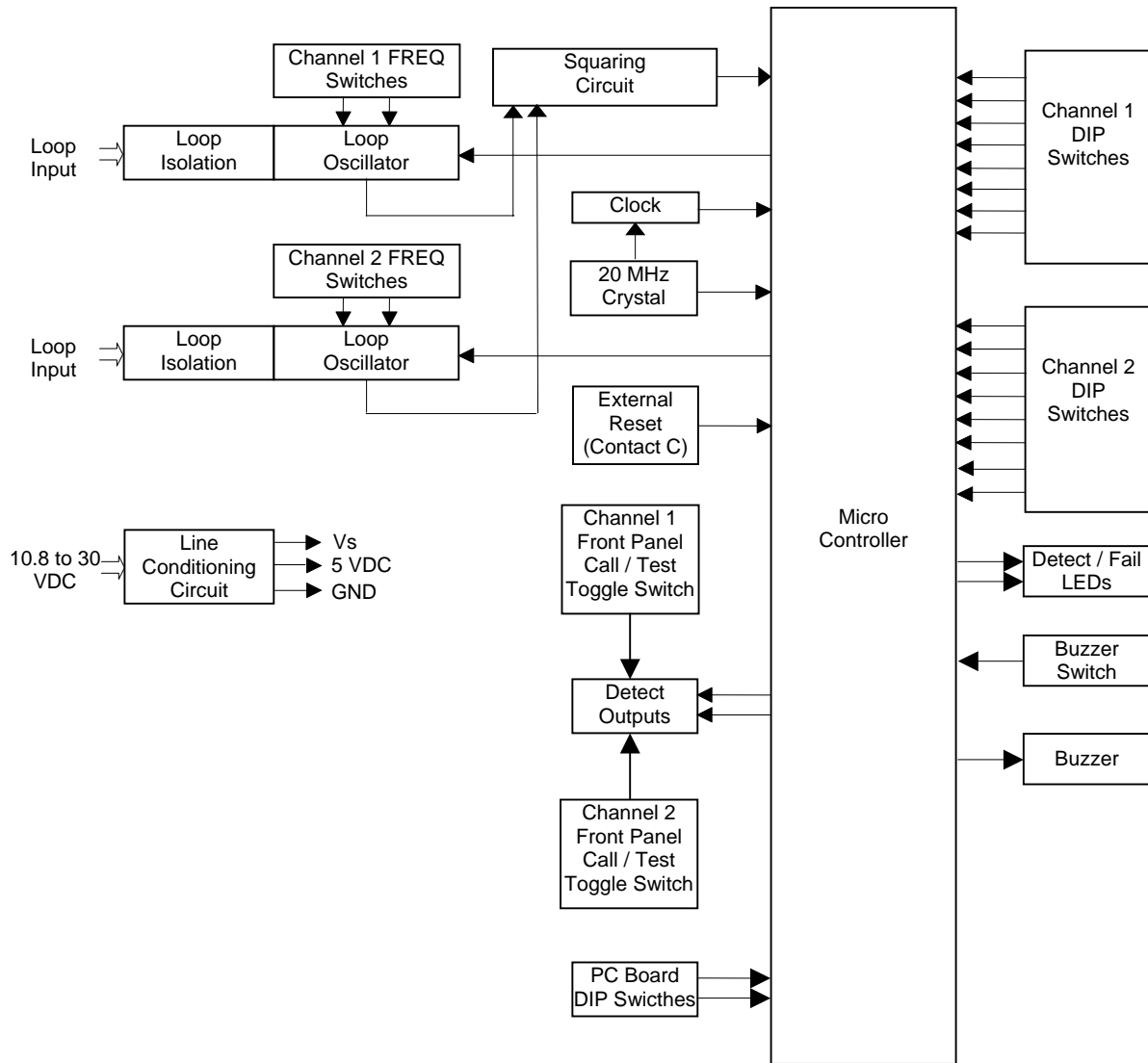

7.0 THEORY OF OPERATION

The Reno A & E Model 222S detector digitally measures changes in the resonant frequency of two independent parallel tuned resonant circuits (loop / lead-in) to determine if a vehicle has entered the detection zones. The detector applies an excitation voltage to each loop circuit resulting in the loop oscillating at its resonant frequency. The current flow in the loop wire creates magnetic fields around the loop wire. When a vehicle passes over the loop area, the conductive metal of the vehicle causes a loading of the loop's magnetic fields. The loading decreases the loop inductance, which causes the resonant frequency to increase. By continuously sampling the loop's resonant frequency, the magnitude and rate of change can be determined. If the frequency change exceeds a selectable threshold (set by the sensitivity settings), the detector will activate an output signal. If the rate of change is slow, typical of environmental drift, the detector will continuously track and compensate for the change. The detector also monitors the loop frequency for out of range conditions such as an opened or shorted loop circuit.

The detector scans the loop / lead-in circuit connected to each detector channel. The scanning method alternates the on and off cycle of each channel's loop circuit. Each channel's oscillator circuit supplies the excitation voltage that is coupled to the loop circuit by a loop isolation transformer. The transformer provides high common mode isolation between the loop and detector electronics, which allows the detector to operate on poor quality loops including a single short to ground. The transformer also limits the amount of static energy (lightning) that can transfer to the detector electronics. A spark gap transient suppression device is connected across the loop inputs to the isolation transformer. This device will dissipate static charges prior to their reaching the transformer. The loop input is also filtered for 60-cycle noise. A network of three capacitors is connected to the detector side of the isolation transformer. The capacitors can be switched in or out of the oscillator circuit to shift the frequency of the loop circuit, thus providing frequency separation between adjacent loops.

The sine wave from the loop circuit is squared for the microcontroller to digitally measure the period of several cycles. A high-speed clock sets a reference count for the period in a counter. If the frequency increases, the period is shorter and the period count decreases. By comparing the new count with the reference count, a percentage of change can be calculated that indirectly relates to the inductance change. If the magnitude of the change exceeds a selectable threshold (sensitivity setting), the detector activates the output device.

The rate of change is also monitored. Slow rates of change typical of environmental drift are tracked and automatically compensated for. If the total inductance of the loop input network goes out of the range specified for the detector, or rapidly changes by more than $\pm 25\%$, the channel will immediately enter the programmed Fail-Safe or Fail-Secure mode of operation. Fail-Safe operation generates a continuous call output in the Presence Mode or Pulse Mode. Fail-Secure operation does not generate a call during the loop failure. In both modes of operation, the Detect / Fail LED will turn ON (red) or flash (red) at a one Hz rate and remain ON or continue flashing as long as the loop failure condition exists. If the loop self-heals, the channel will resume operation in a normal manner; except the Detect / Fail LED will begin to flash at a rate of three red flashes per second, thus providing an alert of a prior Loop Fail condition. The Detect / Fail LED will continue indicating the last loop failure condition until the detector is manually reset or power is removed.

The detector is designed to operate from D.C. power sources providing either 12 VDC or 24 VDC. On-board regulators provide regulated voltages so that the detector can safely operate over the full input voltage range of 10.8 VDC to 30 VDC. The unit is also provided with an external reset capability. When Contact C of the edge card connector receives a logic ground signal for a minimum of 30 microseconds, both channels of the detector are immediately reset. Changing any front panel switch (except the frequency switches) resets the associated channel.

The operating parameters of each detector channel are established by switch settings on two front panel mounted DIP switch modules and a PC board mounted DIP switch module. Operating parameters that can be selected by means of the front panel DIP switches are: Channel Disable, Loop Frequency, Fail-Safe / Fail-Secure Operation, Presence / Pulse Mode, and Sensitivity. Operating parameters that can be selected via the PC board mounted DIP switches are: Test Mode and 100 Millisecond Minimum Output. The loop frequency switches are directly connected to the tuning capacitors in the loop oscillator circuits. The settings of the remaining switches are strobed into the microprocessor. The microprocessor provides a separate output line for each channel. Each output line drives a Fail-Safe optically isolated transistor. Solid state output devices provide faster turn ON and turn OFF times thus giving more accurate information when the detector is used in speed and/or occupancy applications. Other output signals are connected to two, dual color (green / red), front panel mounted Detect / Fail LEDs. Each LED corresponds to an individual detector channel. The Detect / Fail LEDs are normally extinguished when there are no detect outputs, the loops are in tolerance, and there have been no previous failure conditions. A Detect / Fail LED will be steady ON (green) when a current detect output state exists. A Detect / Fail LED will be steady ON (red) when a current open loop failure or an inductance change condition of more than $+25\%$ exists. A Detect / Fail LED will flash at a one Hz rate (red) when a current shorted loop failure or an inductance change condition of more than -25% exists. When a Detect / Fail LED flashes at a rate of three 50 millisecond flashes per second (red), it is an indication that the loop is currently in tolerance, but the detector channel has previously experienced an out of tolerance condition. If a current detect output state exists and a detector channel has previously experienced an out of tolerance condition, the corresponding Detect

/ Fail LED will flash at a rate of three 50 millisecond flashes per second (red) followed by a single 750 millisecond flash (green). Either of these prior failure Detect / Fail LED flashing conditions will be reset whenever an external reset occurs on Pin C, the channel is reset, or power is interrupted.

The detector offers a choice of operation in either Fail-Safe or Fail-Secure mode. Fail-Safe operation is the proper choice for intersection control applications where the detector should output a vehicle detect condition in the event of either a loop failure or power failure condition. Fail-Secure operation is the proper choice for freeway management applications where it is undesirable for the detector to output a vehicle detect condition for a loop failure condition. A vehicle detect condition on a freeway would be considered a stalled vehicle.

The Reno A & E Model 222S detector is designed and manufactured using the latest available technology in electronic design and manufacturing, thus providing the highest possible performance and reliability. Once properly installed a Reno A & E loop detector will provide years of trouble free operation.

8.0 MAINTENANCE AND TROUBLESHOOTING

The Reno A & E Model 222S detector requires no maintenance. If you are having problems with your Model 222S detector, use the troubleshooting chart below to help determine the cause of the problem.

Symptom	Where To Start
No LEDs lit and detector does not respond to traffic.	See Troubleshooting Power Problems . Check for sensitivity set extremely low (0 to 2).
Both Channel's LEDs are ON (Green) and cannot be turned OFF, even when the channel is disabled.	Check the RESET line (Contact C), the detector is being continually reset.
LOOP FAIL indication (LED ON Red or flashing Red at a one Hz rate).	See Troubleshooting Loop Fail Problems .
Previous LOOP FAIL indication (LED flashing three times per second Red) and detector appears to be working correctly.	See Troubleshooting Intermittent Loop Fail Problems .
Detector intermittently stays in the Call state (LED ON Green).	See Troubleshooting Intermittent Detector Lock Ups .

8.1 Troubleshooting Power Problems

Do either of the two front panel Detect / Fail LEDs turn ON (Green) when the detector is powered up and a vehicle is over one of the loops connected to the detector?

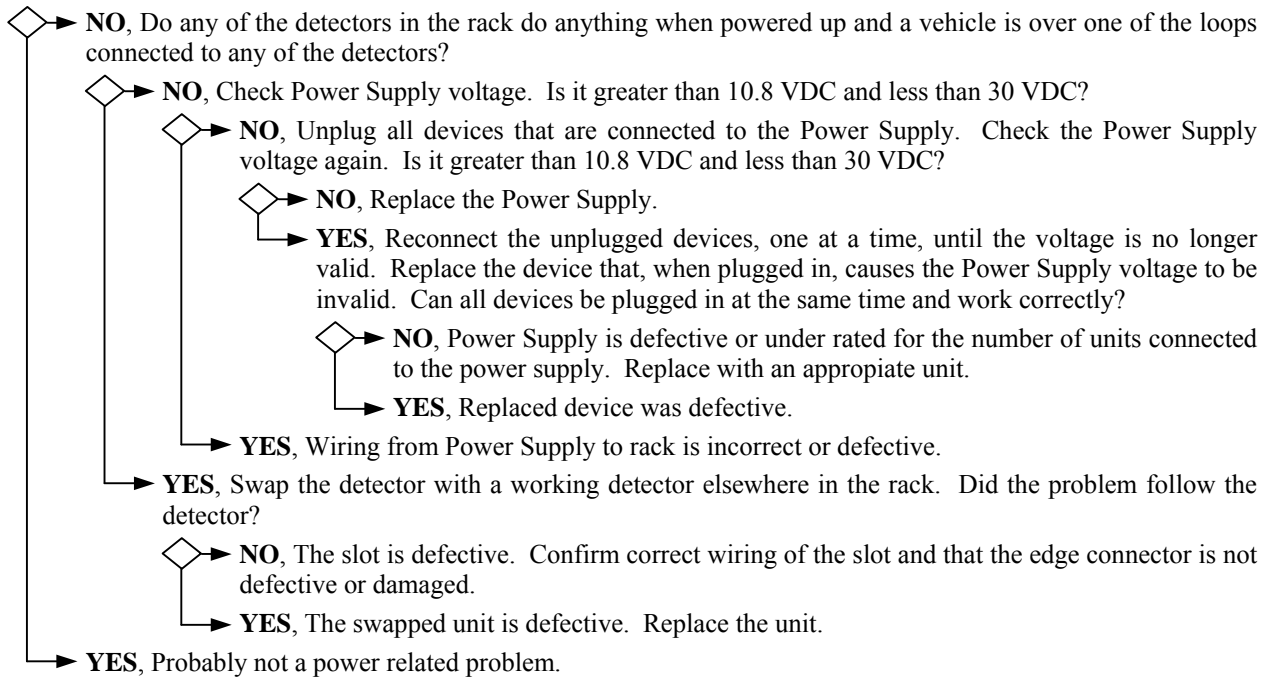

8.2 Troubleshooting Loop Fail Problems

Does either of the two front panel Detect / Fail LEDs show a Loop Failure indication (ON Red or one Hz flash rate Red)?

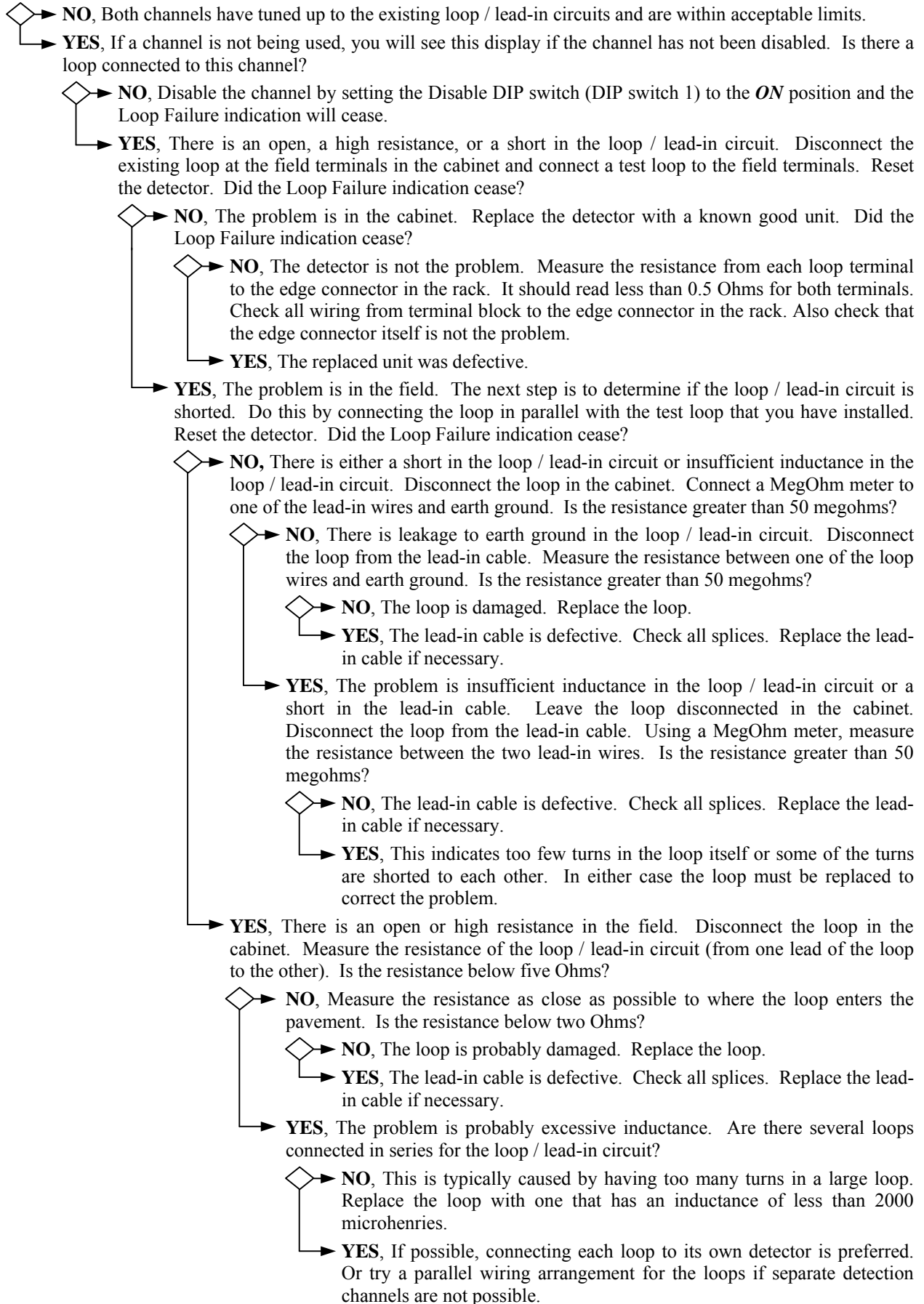

8.3 Troubleshooting Intermittent Loop Fail Problems

Intermittent Loop Fail problems tend to be associated with bad splices in the loop / lead-in circuit, shorts in the loop / lead-in circuit, shorts to earth ground in the loop / lead-in circuit, or loose connections or bad solder joints in the signal cabinet. If you have any splices that are not soldered and sealed with an adhesive heat shrink or epoxy resin, replace the splice with one that is. Using a MegOhm meter, measure the resistance from one of the loop wires to earth ground. It should be greater than 50 megaohms. Inspect the loop. Look for exposed wires or debris pressed into the saw cut. Tighten all screw terminals in the signal cabinet that the loop circuit uses. Check solder joints in the loop circuit, especially on the rack itself. Disconnect and reconnect any connector used in the loop circuit and check for loose pins and sockets in these connectors. If your cabinet has lightning or surge suppression devices on the loop inputs in the cabinet, remove or replace them. Check for places in the field where the loop wire or lead-in cable may be pinched or chaffed. Look for wires pinched under junction box covers and where the wire enters conduit, especially where the loop wire leaves the saw cut and enters a conduit. After checking all of the above items, you could swap out the detector but this type of failure is rarely ever related to the detector.

8.4 Troubleshooting Intermittent Detector Lock Ups

Problems of this type tend to be difficult to isolate due to the many possible causes and the short duration of the symptom (usually less than 30 minutes). If the problem occurs more frequently in the morning or when raining, suspect a short to earth ground in the loop / lead-in circuit. This can usually be verified by testing with a MegOhm meter but not always. Vibration can also be a possible cause. Loop wires may be moving slightly in a conduit due to vibrations from truck traffic. Utility lids in the street near the loop may also be a source of problems. Ensure that lids near a loop are bolted down so that they cannot move. Check that each set of loop wires is twisted together in any pull boxes and that lengths are not excessive. Inspect the loop. Look for exposed wires or debris pressed into the saw cut. Check for places in the field where the loop wire or lead-in cable may be pinched or chaffed. Look for wires pinched under junction box covers and where the wire enters a conduit, especially where the loop wire leaves the saw cut and enters a conduit. **If your cabinet has lightning or surge suppression devices on the loop inputs in the cabinet, remove or replace them.** If you have any splices that are not soldered and sealed with an adhesive heat shrink or epoxy resin, replace the splice with one that is. Solder all crimp connections in the loop circuit. Tighten all screw terminals in the signal cabinet that the loop circuit uses. Check solder joints in the loop circuit, especially on the harness itself. Disconnect and reconnect any connector used in the loop circuit and check for loose pins and sockets in these connectors.

8.5 Test Mode Operation

Test Mode uses the microcontroller to verify the proper operation of the detector's controls and indicators (switches and LEDs). Each channel's loop oscillator circuit is also checked to verify the correct frequency in each of the four frequency selections. The frequency portion of the test requires the detector to be connected to a 100 microhenry loop. If an inductance value other than 100 microhenries is used, the frequency test results will be invalid.

NOTE: The test procedures outlined below should not be performed in an operational traffic signal cabinet.

Test Procedure (PC Board Mounted DIP switches):

- STEP 1. Remove power from the detector.
- STEP 2. Set all front panel Channel 1 programming DIP switches (SW1) to the *OFF* position.
- STEP 3. Set all front panel Channel 2 programming DIP switches (SW2) to the *OFF* position.
- STEP 4. Set both front panel Call / Test toggle switches (SW3 and SW4) to the *NORM* (center) position.
- STEP 5. Set all PC board mounted DIP switches (S3) to the *OFF* position.
- STEP 6. Insert the detector into a suitable test fixture and apply power. Both of the detector's LED indicators should be *OFF*. Set the TEST switch (switch 1 on the PC board mounted DIP switch module, S3) to the *ON* position. Both LED indicators should remain *OFF*. **NOTE: To test the frequency range the channel must be connected to a 100 microhenry loop.** The other tests may be performed with loops within the range of 20 to 2000 microhenries.
- STEP 7. Turn *ON* the 100 MS Minimum Output switch on the PC board mounted DIP switch module (S3). The detector's Channel 1 Detect / Fail LED should turn *ON* (red).
- STEP 8. Turn *OFF* the 100 MS Minimum Output switch on the PC board mounted DIP switch module (S3). The detector's Channel 1 Detect / Fail LED should turn *OFF*.
- STEP 9. Remove power from the detector.

Test Procedure (Programming DIP switches):

- STEP 1. Remove power from the detector.
- STEP 2. Set all front panel Channel 1 programming DIP switches (SW1) to the *OFF* position.
- STEP 3. Set all front panel Channel 2 programming DIP switches (SW2) to the *OFF* position.
- STEP 4. Set both front panel Call / Test toggle switches (SW3 and SW4) to the *NORM* (center) position.
- STEP 5. Set all PC board mounted DIP switches (S3) to the *OFF* position.
- STEP 6. Insert the detector into a suitable test fixture and apply power. Both of the detector's LED indicators should be OFF. Set the TEST switch (switch 1 on the PC board mounted DIP switch module, S3) to the *ON* position. Both LED indicators should remain OFF. **NOTE: To test the frequency range the channel must be connected to a 100 microhenry loop.** The other tests may be performed with loops within the range of 20 to 2000 microhenries.
- STEP 7. Individually, turn ON switches 8, 7, 6, 5, 4, and 1 of the Channel 1 programming DIP switch module (SW1). Turn OFF each switch after verifying the results indicated in the table below.

Switch Label	Switch #	LED Indications and Outputs
SENSE LEVEL 4	8	CH 1 DETECT / FAIL LED ILLUMINATED - GREEN
SENSE LEVEL 2	7	CH 1 DETECT / FAIL LED ILLUMINATED - RED
SENSE LEVEL 1	6	CH 1 DETECT / FAIL LED ILLUMINATED - GREEN
PRES PULS	5	CH 1 DETECT / FAIL LED ILLUMINATED - RED
FAIL SAFE	4	CH 1 DETECT / FAIL LED ILLUMINATED - GREEN
DISABLE	1	CH 1 DETECT / FAIL LED ILLUMINATED - RED

- STEP 8. Individually, turn ON switches 8, 7, 6, 5, 4, and 1 of the Channel 2 programming DIP switch module (SW2). Turn OFF each switch after verifying the results indicated in the table below.

Switch Label	Switch #	LED Indications and Outputs
SENSE LEVEL 4	8	CH 2 DETECT / FAIL LED ILLUMINATED - GREEN
SENSE LEVEL 2	7	CH 2 DETECT / FAIL LED ILLUMINATED - RED
SENSE LEVEL 1	6	CH 2 DETECT / FAIL LED ILLUMINATED - GREEN
PRES PULS	5	CH 2 DETECT / FAIL LED ILLUMINATED - RED
FAIL SAFE	4	CH 2 DETECT / FAIL LED ILLUMINATED - GREEN
DISABLE	1	CH 2 DETECT / FAIL LED ILLUMINATED - RED

- STEP 9. Remove power from the detector.

Test Procedure (Frequency DIP switches):

- STEP 1. Remove power from the detector.
- STEP 2. Set all front panel Channel 1 programming DIP switches (SW1) to the *OFF* position.
- STEP 3. Set all front panel Channel 2 programming DIP switches (SW2) to the *OFF* position.
- STEP 4. Set both front panel Call / Test toggle switches (SW3 and SW4) to the *NORM* (center) position.
- STEP 5. Set all PC board mounted DIP switches (S3) to the *OFF* position.
- STEP 6. Insert the detector into a suitable test fixture and apply power. Both of the detector's LED indicators should be OFF. Set the TEST switch (switch 1 on the PC board mounted DIP switch module, S3) to the *ON* position. Both LED indicators should remain OFF. **NOTE: To test the frequency range the channel must be connected to a 100 microhenry loop.** The other tests may be performed with loops within the range of 20 to 2000 microhenries.

STEP 7. Individually, turn ON switches 3 and 2 of the Channel 1 programming DIP switch module (SW1). Turn OFF each switch after verifying the results indicated in the table below.

Switch Label	Switch #	LED Indications and Outputs
FREQ 1	3	CH 1 DETECT / FAIL LED ILLUMINATED - GREEN
FREQ 2	2	CH 1 DETECT / FAIL LED ILLUMINATED - RED

STEP 8. Individually, turn ON switches 3 and 2 of the Channel 2 programming DIP switch module (SW2). Turn OFF each switch after verifying the results indicated in the table below.

Switch Label	Switch #	LED Indications and Outputs
FREQ 1	3	CH 2 DETECT / FAIL LED ILLUMINATED - GREEN
FREQ 2	2	CH 2 DETECT / FAIL LED ILLUMINATED - RED

STEP 9. Remove power from the detector.

An LED indication different than the ones described for each switch setting indicates the loop frequency is out of tolerance. Verify that the loop test coil has an inductance of 100 microhenries. If the test loop measures 100 microhenries the detector module should be serviced.

Test Procedure (Front Panel Call / Test switches):

STEP 1. Remove power from the detector.

STEP 2. Refer to the table in Section 3.5 and set all front panel programming DIP switches (SW1 and SW2) to their default positions.

STEP 3. Set both front panel Call / Test toggle switches (SW3 and SW4) to the *NORM* (center) position.

STEP 4. Set all PC board mounted DIP switches (S3) to the *OFF* position.

STEP 5. Insert the detector into a suitable test fixture and apply power. Both of the detector's LED indicators should be OFF. **NOTE: To test the frequency range, the channel must be connected to a 100 microhenry loop.** The other tests may be performed with any loops within the range of 20 to 2000 microhenries.

STEP 6. Move the Channel 1 Call / Test toggle switch to the *CALL* position. The test fixture's Channel 1 Detect LED should turn ON.

STEP 7. Return the Channel 1 Call / Test toggle switch to the *NORM* position. The test fixture's Channel 1 Detect LED should turn OFF.

STEP 8. Move the Channel 1 Call / Test toggle switch to the *TEST* position and hold it there. The test fixture's Channel 1 Detect LED should turn ON.

STEP 9. Release the Channel 1 Call / Test toggle switch and allow it to return to the *NORM* position. The test fixture's Channel 1 Detect LED should turn OFF.

STEP 10. Move the Channel 2 Call / Test toggle switch to the *CALL* position. The test fixture's Channel 2 Detect LED should turn ON.

STEP 11. Return the Channel 2 Call / Test toggle switch to the *NORM* position. The test fixture's Channel 2 Detect LED should turn OFF.

STEP 12. Move the Channel 2 Call / Test toggle switch to the *TEST* position and hold it there. The test fixture's Channel 2 Detect LED should turn ON.

STEP 13. Release the Channel 2 Call / Test toggle switch and allow it to return to the *NORM* position. The test fixture's Channel 2 Detect LED should turn OFF.

STEP 9. Remove power from the detector.

Test Procedure (Front Panel Buzzer switch):

- STEP 1. Remove power from the detector.
- STEP 2. Refer to the table in Section 3.5 and set all front panel programming DIP switches (SW1 and SW2) to their default positions.
- STEP 3. Set both front panel Call / Test toggle switches (SW3 and SW4) to the *NORM* (center) position.
- STEP 4. Set all PC board mounted DIP switches (S3) to the *OFF* position.
- STEP 5. Insert the detector into a suitable test fixture and apply power. Both of the detector's LED indicators should be OFF. **NOTE: To test the frequency range, the channel must be connected to a 100 microhenry loop.** The other tests may be performed with any loops within the range of 20 to 2000 microhenries.
- STEP 6. Press the front panel mounted switch labeled **BUZZER**. The buzzer should sound once (50 ms).
- STEP 7. Perform the actions and verify the results indicated in the table below.

Action	LED Indications and Outputs
INPUT CALL CHANNEL 1	<ul style="list-style-type: none">• CHANNEL 1 DETECT / FAIL LED ILLUMINATED - ORANGE• BUZZER SOUNDS
REMOVE CALL CHANNEL 1	<ul style="list-style-type: none">• CHANNEL 1 DETECT / FAIL LED OFF• BUZZER OFF

- STEP 8. Press the front panel mounted switch labeled **BUZZER**. The buzzer should sound twice (50 ms).
- STEP 9. Perform the actions and verify the results indicated in the table below.

Action	LED Indications and Outputs
INPUT CALL CHANNEL 2	<ul style="list-style-type: none">• CHANNEL 2 DETECT / FAIL LED ILLUMINATED - ORANGE• BUZZER SOUNDS
REMOVE CALL CHANNEL 2	<ul style="list-style-type: none">• CHANNEL 2 DETECT / FAIL LED OFF• BUZZER OFF

- STEP 10. Press the front panel mounted switch labeled **BUZZER**. The buzzer should sound once (250 ms).
- STEP 11. Remove power from the detector.

Test Procedure (Reset):

- STEP 1. Remove power from the detector.
- STEP 2. Refer to the table in Section 3.5 and set all front panel programming DIP switches (SW1 and SW2) to their default positions.
- STEP 3. Set both front panel Call / Test toggle switches (SW3 and SW4) to the *NORM* (center) position.
- STEP 4. Set all PC board mounted DIP switches (S3) to the *OFF* position.
- STEP 5. Insert the detector into a suitable test fixture and apply power. Both of the detector's LED indicators should be OFF. **NOTE: To test the frequency range, the channel must be connected to a 100 microhenry loop.** The other tests may be performed with any loops within the range of 20 to 2000 microhenries.

STEP 6. Perform the actions and verify the results indicated in the table below. NOTE: Unless otherwise noted, references to switches, buttons, or inputs in the table correspond to labels on test equipment supplied by Reno A & E.

Switch / Button / Input	Action	LED Indications and Outputs
CHANNEL 1 OPEN LOOP BUTTON	PRESS AND HOLD	<ul style="list-style-type: none"> DETECTOR CHANNEL 1 DETECT / FAIL LED ILLUMINATED - RED DETECTOR CHANNEL 1 OUTPUT ON TEST FIXTURE CHANNEL 1 DETECT LED ON
CHANNEL 1 OPEN LOOP BUTTON	RELEASE	<ul style="list-style-type: none"> DETECTOR CHANNEL 1 DETECT / FAIL LED FLASH - RED (THREE 50 ms FLASHES PER SECOND) DETECTOR CHANNEL 1 OUTPUT OFF TEST FIXTURE CHANNEL 1 DETECT LED OFF
RESET BUTTON	PRESS AND RELEASE	<ul style="list-style-type: none"> DETECTOR CHANNEL 1 DETECT / FAIL LED OFF
CHANNEL 2 OPEN LOOP BUTTON	PRESS AND HOLD	<ul style="list-style-type: none"> DETECTOR CHANNEL 2 DETECT / FAIL LED ILLUMINATED - RED DETECTOR CHANNEL 2 OUTPUT ON TEST FIXTURE CHANNEL 2 DETECT LED ON
CHANNEL 2 OPEN LOOP BUTTON	RELEASE	<ul style="list-style-type: none"> DETECTOR CHANNEL 2 DETECT / FAIL LED FLASH - RED (THREE 50 ms FLASHES PER SECOND) DETECTOR CHANNEL 2 OUTPUT OFF TEST FIXTURE CHANNEL 2 DETECT LED OFF
RESET BUTTON	PRESS AND RELEASE	<ul style="list-style-type: none"> DETECTOR CHANNEL 2 DETECT / FAIL LED OFF

STEP 7. Remove power from the detector.

8.6 Voltage and Waveform Measurements

The following voltage and waveform measurements are referenced to logic ground on Contact A of the edge card connector.

VOLTAGES:

1. Verify 10.8 to 30 VDC on Contact B of the edge card connector.
2. Verify 5 VDC on the following:
 - Pin 3 of U1 (regulator)
 - Pin 3 of U10 (regulator)
 - Pin 1 (Reset) and Pin 20 (VCC) of U7 (microcontroller).
3. Verify channel 1 and 2 oscillator sine wave (shown in Figure 1) forms across LA1 and LA2 (surge protectors). The sine wave should be 8 to 10 V_{p-p} and between 20 and 100 kHz.
4. Verify channel 1 and 2 oscillator scan signals (shown in Figure 2) on Pins 2 and 3 of U7 respectively.
5. Verify the comparator square wave on Pin 5 of U4 (Figure 3). Turn OFF one of the channels with the front panel DISABLE switch to verify the operation of the other channel.
6. Verify the operation of the crystal on Pin 10 of U7 (Figure 4).

WAVE FORMS:

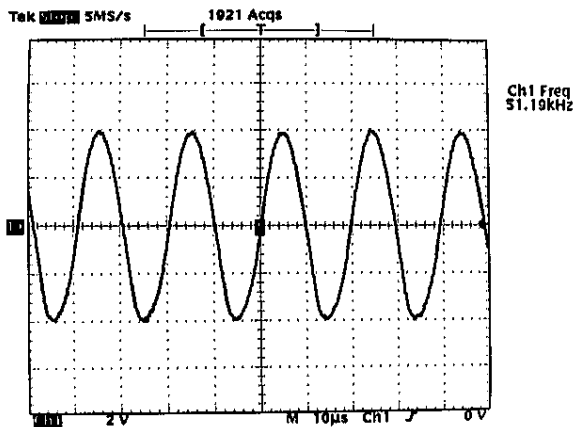

Figure 1.

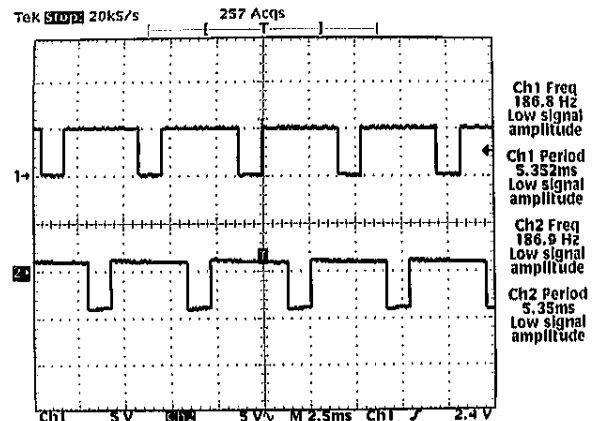

Figure 2.

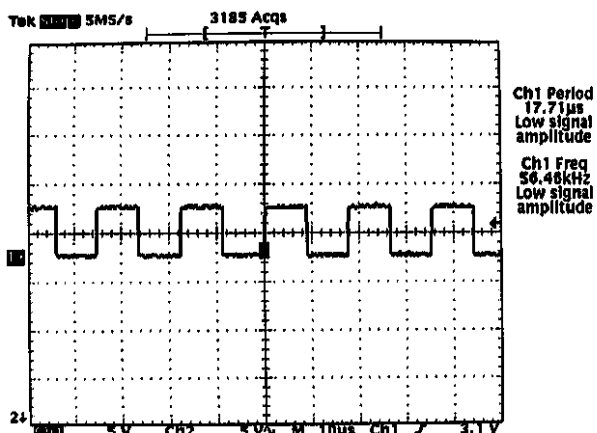

Figure 3.

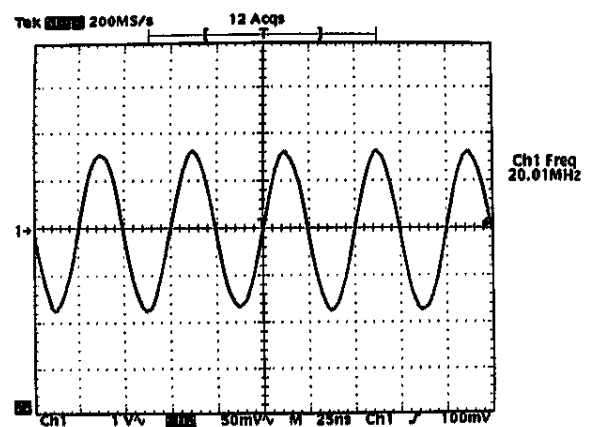

Figure 4.

8.7 Things To Know About Loops

Always use a wire with cross-linked Polyethylene insulation (insulation type XLPE) for loop wire.

Typical sensing height is $\frac{2}{3}$ of the shortest leg of a loop. Therefore, a 6' x 6' loop will have a detection height of 4'.

The inductance of a conventional four-sided loop can be estimated using the formula:

$$L = P \times (T^2 + T) / 4$$

Where: L = Loop Inductance in microhenries

P = Loop Perimeter in feet

T = Number of Turns of Wire.

Therefore, a 6' by 6' loop with 3 turns would have an inductance of:

$$L = (6 + 6 + 6 + 6) \times (3^2 + 3) / 4$$

$$L = 24 \times (9 + 3) / 4$$

$$L = 24 \times 12 / 4$$

$$L = 24 \times 3$$

$$L = 72 \text{ microhenries.}$$

The inductance of a Quadrupole™ loop can be estimated using the formula:

$$L = [P \times (T^2 + T) / 4] + [CL \times (T^2 + T) / 4]$$

Where: L = Loop Inductance in microhenries

P = Loop Perimeter in feet

T = Number of Turns of Wire

CL = Length of Center Leg in feet.

Therefore, a 6' by 50' loop with a 2-4-2 configuration would have an inductance of:

$$L = [(6 + 50 + 6 + 50) \times (2^2 + 2) / 4] + [50 \times (4^2 + 4) / 4]$$

$$L = [112 \times (4 + 2) / 4] + [50 \times (16 + 4) / 4]$$

$$L = (112 \times 6 / 4) + (50 \times 20 / 4)$$

$$L = (112 \times 1.5) + (50 \times 5)$$

$$L = 168 + 250$$

$$L = 418 \text{ microhenries.}$$

Loop Feeder cable typically adds 0.22 microhenries of inductance per foot of cable.

Total inductance of loops connected in series:

$$L_{TOTAL} = L_1 + L_2 + L_3 + \dots + L_N.$$

Total inductance of loops connected in parallel:

$$L_{TOTAL} = 1 / [(1 / L_1) + (1 / L_2) + (1 / L_3) + \dots + (1 / L_N)].$$

This page intentionally left blank.